

PNEUMATIC CARTON STAPLER

MODEL:

MANUAL

WARNING

BEFORE OPERATING THIS STAPLER. ALL OPERATORS SHOULD STUDY THIS MANUAL, TO UNDERSTAND AND FOLLOW THE SAFETY WARNINGS AND INSTRUCTIONS. KEEP THESE INSTRUCTIONS WITH THE STAPLER FOR FUTURE REFERENCE. IF YOU HAVE ANY QUESTION, CONTACT YOUR DISTRIBUTOR.

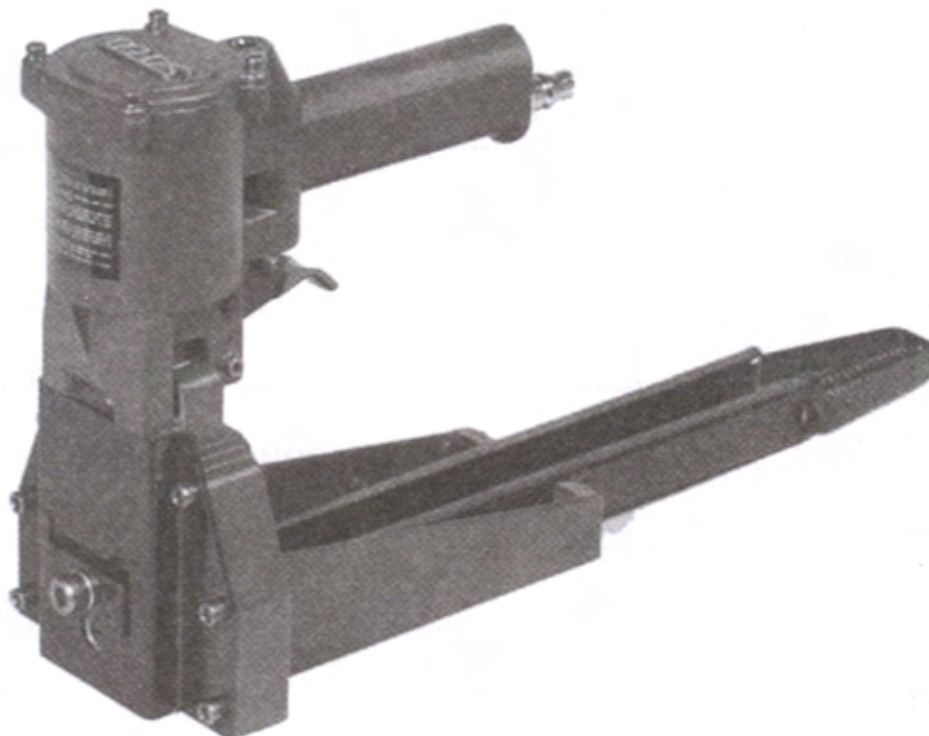

TABLE OF CONTENTS

TOOL SPECIFICATIONS.....	2
SAFETY INSTRUCTIONS.....	3
LUBRICATION AND MAINTENANCE	4
AIR SUPPLY AND CONNECTIONS	4
LOADING THE TOOL	5
CHECK STAPLE LEG LENGTH	6
CLINCH ADJUSTMENT	7
DEPTH ADJUSTMENT	7
OPERATING THE TOOL	8
CLEANING THE TOOL	9
CLEARING A JAM FROM THE TOOL	10
TROUBLESHOOTING	11
TEETH REPLACEMENT	12
DRIVER REPLACEMENT	13
VALVE'S AND TUBE'S O RINGS REPLACEMENT	14
PISTON REPLACEMENT	15
PISTON REPLACEMENT.....	16
PARTS LIST	17
EXPLODED VIEW OF TOOL	18

TOOL SPECIFICATIONS

MODEL OF TOOL	
DIMENSIONS (LENGTH * HEIGHT * WIDTH)	410MM * 220MM * 115MM
WEIGHT (WITHOUT FASTENERS)	2.65KG
AIR INLET1/4" NPT
COMPRESSED AIR :	
MAXIMUM PERMISSIBLE OPERATING PRESSURE.....	8KG/CM ²
RECOMMENDID OPERATING PRESSURE	5KG/ CM ² -7KG/CM ²
AIR CONSUMPTION	0.067 M ³ /MIN (2.4 C.F.M) WITH 60 STAPLES PER MINUTE @5.66KG/ CM ² (80 PSI)
STAPLES SPECIFICATION	CROWN LENGTH 15MM,18MM.
STAPLES CAPACITY	1000 PCS
THE NOISE LEVELS : (AT THE WORKPLACE, ALWAYS WEAR HEARING PROTECTION EQUIPMENT.)	
A - EIGHTED SINGLE-EVENT SOUND PPRESSIONE LEVEL AT OPERATOR'S POSITION:L pA, 1s =	89 dBA
A - WEIGHTED SINGLE-EVENT SOUND POWER LEVEL	L WA, 1s = 93 dBA
A - WEIGHTED SINGLE-EVENT SURFACE SOUND PRESSURE LEVEL	L Pa, 1s, 1m= 80 dBA

SAFETY INSTRUCTIONS

DANGER

1. READ THIS MANUAL AND UNDERSTAND ALL SAFETY INSTRUCTIONS BEFORE OPERATION THE TOOL. IF YOU HAVE ANY QUESTIONS, PLEASE CONTACT OUR AUTHORIZED REPRESENTATIVES.
2. NEVER ALLOW TO USE TYPE OF FLAMMABLE GASES OXYGEN AS A POWER SOURCE FOR THE TOOL. USE FILTERED, LUBRICATED, REGULATED COMPRESSED AIR ONLY.
3. NEVER USE GASOLINE OR OTHER FLAMMABLE LIQUIDS TO CLEAN THE TOOL VAPORS IN THE TOOL WILL IGNITE BY A SPARK AND CAUSE THE TOOL TO EXPLODE.
4. DO NOT EXCEED MAXIMUM PERMISSIBLE OPERATING PRESSURE OF THE TOOL (8 KG/Cm²)
5. DISCONNECT THE TOOL FROM AIR SUPPLY BEFORE CLEANING JAMS, SERVICING, ADJUSTING, AND DURING NON-OPERATION.

WARNING

6. DO NOT PULL THE TRIGGER WHEN CARRYING OR HOLDING THE TOOL. NEVER CARRY THE TOOL BY THE HOSE OR PULL THE HOSE TO MOVE THE TOOL.
7. AT THE WORKPLACE, ALWAYS WEAR THE PROTECTIVE EQUIPMENT SUCH AS SAFETY GLASSES, HEARING PROTECTION AND HEAD PROTECTION.
8. DO NOT USE A CHECK VALVE OR ANY OTHER FITTING WHICH ALLOWS AIR TO REMAIN IN THE TOOL.
9. DO NOT PLACE YOUR HAND OR ANY PART OF YOUR BODY IN THE STAPLE CLINCHING AREA OR ADJUSTMENT WINDOW OF THE TOOL WHEN CONNECTING OR DISCONNECTING AIR SUPPLY.
10. NEVER POINT ANY OPERATIONAL DRIVING TOOL AT YOURSELF OR AT ANY OTHER PERSON.

LUBRICATION AND MAINTENANCE

NOTE

YOUR TOOL REQUIRES LUBRICATION BEFORE YOU USE IT FOR THE FIRST TIME.

DISCONNECT THE AIR SUPPLY FROM THE TOOL BEFORE LUBRICATING.

TURN THE TOOL SO THE INLET IS FACING UP AND PUT ONE DROP OF HIGH SPEED SPINDLE OIL, UNOCAL RX22, OR 3-IN-1 OIL INTO AIR INLET. NEVER USE DETERGENT OIL ADDITIVES. OPERATE THE TOOL BRIEFLY AFTER ADDING OIL.

WIPE OFF EXCESSIVE OIL AT THE EXHAUST, EXCESSIVE OIL WILL DAMAGE ORINGS OF TOOL. IF IN-LINE OILER IS USED. MANUAL LUBRICATION THROUGH THE AIR INLET IS NOT REQUIRED ON A DAILY BASIS.

AIR SUPPLY AND CONNECTIONS

NOTE

THE FOLLOWING ILLUSTRATION SHOWS THE CORRECT MODE OF CONNECTION TO THE AIR SUPPLY SYSTEM WHICH WILL INCREASE THE EFFICIENCY AND USE. FULL LIFE OF THE TOOL.

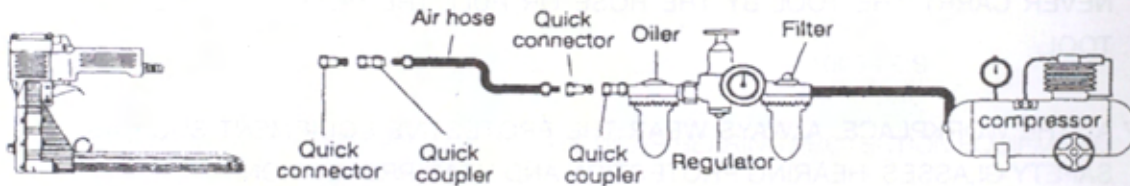

MANY AIR TOOL USERS FIND IT CONVENIENT TO USE OILER TO HELP PROVIDE OIL CIRCULATION THROUGH TOOL AND INCREASE THE EFFICIENCY AND USEFUL LIFE OF THE TOOL. CHECK OIL LEVEL IN THE OILER DAILY.

MANY AIR TOOL USER FIND IT CONVENIENT TO USE A FILTER TO REMOVE LIQUID IMPURITIES WHICH CAN RUST OR WEAR INTERNAL PARTS OF THE TOOL. A FILTER ALSO INCEREASE THE EFFICIENCY AND USEFUL OF THE TOOL. THE FILTER MUST BE CHECKED ON A DAIL BASIS AND IF NECESSARY DRAINED.

LOADING THE TOOL

NOTE: DISCONNECT THE AIR SUPPLY

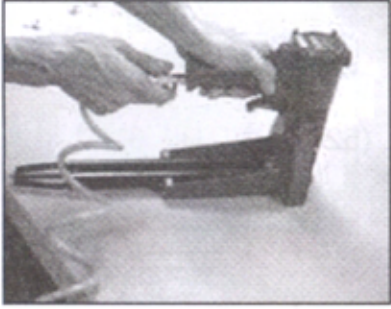

DISCONNECT THE AIR SUPPLY



PRESS THE STOPPER (035), THEN PULL OUT THE PUSHER UNIT (032).



INSERT 2 STICKS OF APPROPRIATE STAPLES INTO THE MAGAZINE UNIT (029) FROM BACK. LET THE STICKS SLIDE FORWARD TO THE FRONT OF THE MAGAZINE UNIT (029).



REASSEMBLE THE PUSHER UNIT (026).



CHECK STAPLE LENGTH

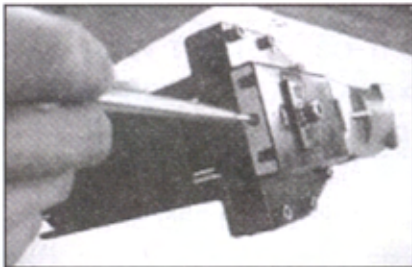

NOTE : DISCONNECT THE AIR SUPPLY



LOOSEN SET SCREW (526) WITH 3MM HEXAGON WRENCH KEY.



TURN ADJUSTING ROD (018) 180° WITH A SCREW DRIVER TO THE DESIRED ADJUSTMENT.

STAPLES LENGTHS	15MM	18MM
ROD POSITION		

IF WANT TO SHOOT LONG LEG STAPLES. LET "L" ON ADJUSTING ROD (018) UP. IF WANT TO SHOOT SHORT LEG STAPLES. LET "S" ON. ADJUSTING ROD (018) UP.

STAPLES LENGTHS	18MM	22MM
ROD POSITION		

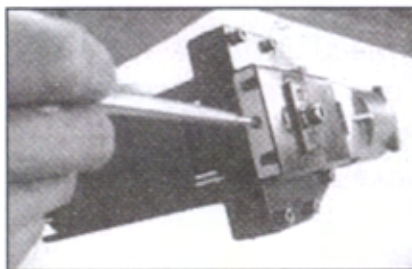

TIGHTEN SET SCREW (526)

CLINCH ADJUSTMENT

NOTE : DISCONNECT THE AIR SUPPLY



USE ROD(DIA 3 MM) OR 2.5 MM HEXAGON WRENCH KEY. TURN COLLAR (006) THROUGH WINDOW CLOCKWISE TO TIGHTEN CLINCH AND COUNTER-CLOCKWISE TO LOOSEN CHINCH.

NOTE : REMOVE ADJUSTING TOOL AFTER ADJUSTMENT IS MADE.

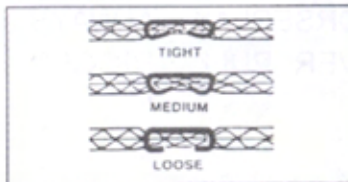

DEPTH ADJUSTMENT

NOTE : DISCONNECT THE AIR SUPPLY



LOOSEN FRONT SCREW (527) WITH 6 MM HEXAGON WRENCH KEY.



PUSH THE BODY (007) UP AND ADJUST TO DESIRED DEPTH.

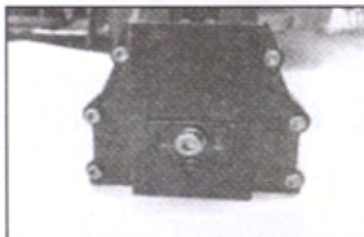

WHEN TOP EDGE OF ADJUSTMENT PLATE (019) IS AT ITS HIGHEST SETTING (NO.4), THE TEETH (021,022) ARE AT THEIR SHALLOWEST PENETRATION. IF SET AT LOWEST SETTING (NO.1) THE TEETH (021,022) ARE AT THEIR DEEPEST PENETRATION.

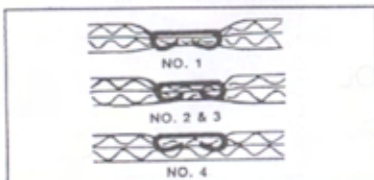

OPERATING THE TOOL

WARNING

PROTECT YOUR EYES AND EARS. WEAR SAFETY GLASSES WITH SIDE SHIELDS. WEAR HEARING PROTECTION. EMPLOYERS AND USERS ARE RESPONSIBLE FOR ENSURING THE USER OR ANYONE NEAR THE TOOL WEAR THIS SAFETY PROTECTION.

WARNING

TO PREVENT ACCIDENTAL INJURIES : NEVER, PLACE A HAND OR ANY OTHER PART OF BODY IN STAPLE CLINCHING AREA OR ADJUSTMENT WINDOW. NEVER POINT TOOL TOWARD ANYONE ELSE. NEVER ENGAGE IN HORSEPLAY. ALWAYS HANDLE THE TOOL WITH CARE. NEVER PULL TRIGGER UNLESS TOOL IS IN PLACE OF CARTON.

NOTE

CHECK AND REPLACE ANY DAMAGED OR WORN COMPONENTS ON THE TOOL. THE SAFETY WARNING LABELS ON THE TOOL MUST ALSO BE REPLACED IF THEY ARE NOT LEGIBLE.



ADD A FEW DROPS OF UNOCAL RX22 OR 3-IN -1 OIL INTO THE AIR INLET.

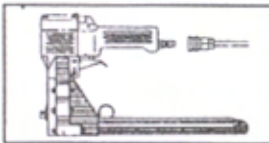

INSTALL A QUICK CONNECT FITTING TO THE TOOL



REGULATE THE AIR PRESSURE TO OBTAIN 6 KG/cm² AT THE TOOL



INSERT STAPLES INTO YOUR TOOL FOLLOWING THE INSTRUCTIONS OF LOADING THE TOOL.



RECONNECT THE AIR HOSE TO THE TOOL



GRASP HANDLE WITH ONE HAND. POSITION ON BOX IN LINE WITH THE DESIRED STAPLE LOCATION. THERE IS A SMALL PROJECTION ON EITHER SIDE OF THE MAGAZINE SEAT (028) AS AN AID IN LOCATING THE POSITION OF THE STAPLE. PRESS TRIGGER (011) MOVE MACHINE TO NEXT STAPLE LOCATION WITH OR WITHOUT RELEASING TRIGGER.



STRONGEST CLOSURE REQUIRES END STAPLES CLOSE TO END OF BOX. CHECK PACKING REQUIREMENTS.

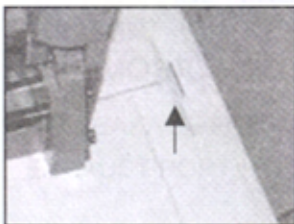

CHECK STAPLE CLINCHING IN SAMPLES OF BOX BOARD BEING USED. ADJUSTMENTS FOR DEPTH OF PENETRATION & TIGHTNESS OF CLINCH ARE EASY & INSTANTANEOUS, FULL ADVANTAGE SHOULD BE TAKEN OF THEM.

CLEANING THE TOOL

DANGER



NEVER USE GASOLINE OR OTHER FLAMMABLE LIQUIDS TO CLEAN THE TOOL. VAPORS IN THE TOOL WILL IGNITE BY A SPARK AND CAUSE THE TOOL TO EXPLODE AND RESULT IN DEATH OR SERIOUS PERSONAL INJURY.

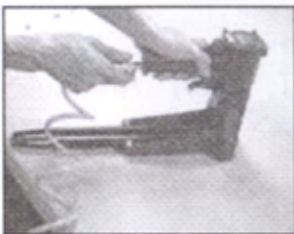

1. DISCONNECT THE AIR SUPPLY FROM THE TOOL.



2. REMOVE TAR BUILDUP WITH KEROSENE #2 FUEL OIL OR DIESEL FUEL. DO NOT ALLOW SOLVENT TO GET INTO THE CYLINDER OR DAMAGE MAY OCCUR. DRY OFF THE TOOL COMPLETELY BEFORE USE.

CLEARING A JAM FROM THE TOOL

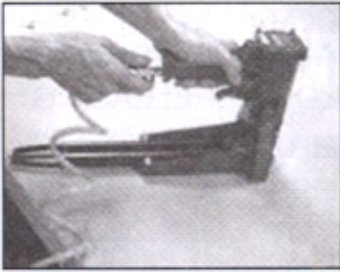

DISCONNECT THE AIR SUPPLY.



TAKE OFF PUSHER UNIT (032) FROM
MAGAZINE UNIT (029).

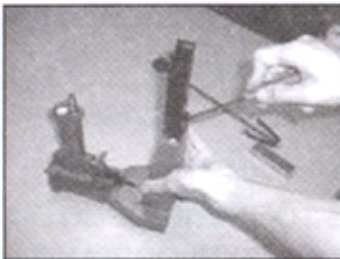

RELEASE MAGAZINE UNIT (029), WITH FLAT
HEAD SCREW DRIVER, THEN CLEAR JAM.



REASSEMBLE MAGAZINE UNIT (029) AND
PUSHER UNIT (032).

TROUBLESHOOTING

WARNING

STOP USING THE TOOL IMMEDIATELY IF ANY OF THE FOLLOWING PROBLEMS OCCUR. SERIOUS PERSONAL INJURY COULD OCCUR. ANY REPAIRS OR REPLACEMENTS MUST BE DONE BY A QUALIFIED PERSON OR AN AUTHORIZED SERVICE CENTER ONLY.

PROBLEM	CAUSE	REMEDY
AIR LEAKAGE FROM TRIGGER.	O-RINGS ON VALVE (016) OR ON TUBE (017) ARE DAMAGED.	O-RINGS MUST BE REPLACED.
AIR LEAKAGE FROM EXHAUST PORT.	O-RINGS ON VALVE (016) OR ON TUBE (017) ARE DAMAGED.	O-RINGS MUST BE REPLACED.
	PISTON'S O-RING (507) IS DAMAGED.	O-RING MUST BE REPLACED.
AIR LEAKAGE FROM CYLINDER.	PISTON ROD PORT O-RING IS DAMAGED.	REPLACE THE O-RING.
SLOW AND SHORT TRAVEL CYCLING	CHECK FOR LOOSE END SCREW (517) AND WEAR OF PARTS (014, 009)	POSITION ECCENTRIC PIN (013) AS SHOWN AND TIGHTEN SCREW (517) RECHECK, FOR MAXIMUM EFFICIENCY, SLIGHT ADJUSTMENT OF PIN AT THE POSITION SHOWN MUST BE MADE UPWARD DIRECTION IF SHORT TRAVEL OCCURS AND DOWNWARD DIRECTION IF SLOW CYCLING OCCURS.
EXCESSIVE JAMS:	SLOW AND SHORT TRAVEL CYCLING.	CHECK AS NOTED IN SLOW AND SHORT TRAVEL CYCLING SECTION.
	TEETH SCREWS LOOSE.	TIGHTEN SCREWS
	STAPLE SIZE IS WRONG.	USE THE PROPER SIZE STAPLE
	INSUFFICIENT LUBRICATION.	CLEANING AND LUBRICATION SUITABLY.
UNEVEN CLINCH	WRONG STAPLE SIZE.	CHECK FOR PROPER LEG LENGTH & ADJUSTMENT CLINCHER.
UNCLINCHED STAPLE	TEETH (021,022) LOOSE	TIGHTEN TEETH (021,022)
	TEETH (021,022) ARE	REPLACE TEETH (021,022)
	SLOW AND SHORT TRAVEL CYCLING.	CHECK AS NOTED IN SLOW AND SHORT TRAVEL CYCLING SECTION.

TEETH REPLACEMENT

NOTE : DISCONNECT THE AIR SUPPLY.

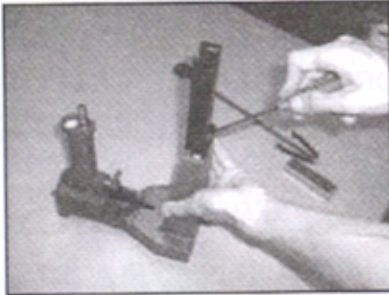

TAKE OFF THE MAGAZINE UNIT (029) WITH FLAT HEAD SCREW DRIVER, THEN CLEAR JAM.



LOOSEN SCREWS (530) WITH 4 MM HEXAGON WRENCH KEY.



REMOVE THE MAGAZINE SEAT (028).



LOOSEN SCREWS (532) WITH 3 MM HEXAGON WRENCH KEY.
CHANGE TEETH ONE AT A TIME TO PREVENT REVERSING TEETH.

DRIVER REPLACEMENT

NOTE : DISCONNECT THE AIR SUPPLY.

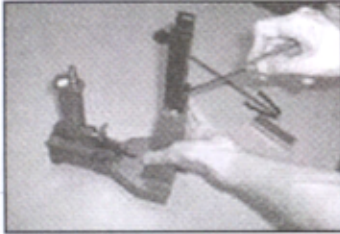

TAKE OFF THE MAGAZINE UNIT (029) WITH FLAT HEAD SCREW DRIVER, THEN CLEAR JAM.



LOOSEN SCREWS (530) WITH 4 MM HEXAGON WRENCH KEY.



REMOVE THE MAGAZINE SEAT (028)



LOOSEN SET SCREW (526) WITH 3 MM HEXAGON WRENCH KEY TO UNLOCK ADJUSTING ROD (018)



SLIDE LINKAGE MECHANISM AND ADJUSTING ROD (018) SIMULTANEOUSLY FROM COLLAR (006).



LOOSEN SCREWS (535) WITH 3 MM HEXAGON WRENCH KEY. TAKE OFF THE SPRING PIN (537) WITH HAMMER AND 6 MM STRAIGHT ROD.

VALVE'S AND TUBE'S O-RINGS REPLACEMENT

NOTE : DISCONNECT THE AIR SUPPLY

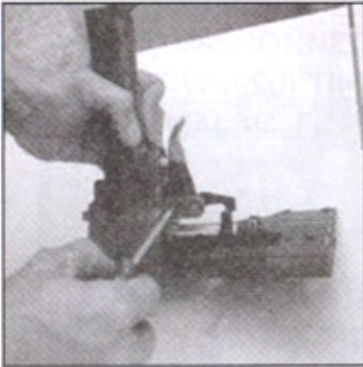

LOOSEN SCREWS (513) WITH FLAT SCREW DRIVER.

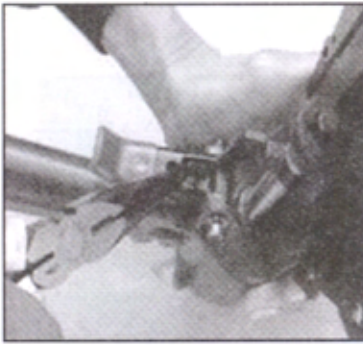

REMOVE SPRING (012) WITH LONG NOSE PLIERS.



REMOVE C-RING (546) WITH A C-RING PLIER.



REMOVE VALVE (017) AND TUBE (016) WITH A LONG NOSE PLIERS.

PISTON REPLACEMENT

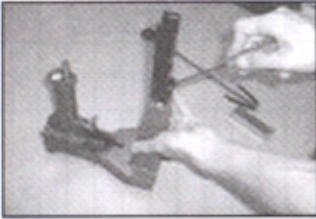

NOTE : DISCONNECT THE AIR SUPPLY

REMOVE THE MAGAZINE ASSEMBLY (029) WITH A FLAT HEAD SCREW DRIVER.



REMOVE SCREWS (530) WITH 4 mm HEXAGON WRENCH KEY .



LOOSEN SET SCREW (526) WITH 3 mm HEXAGON WRENCH KEY TO UNLOCK ADJUSTING ROD (018) .



SLIDE LINKAGE MECHANISM AND ADJUSTING ROD (018) SIMULTANEOUSLY FROM COLLAR (006) .



LOOSEN SPRING PIN (511) WITH 3 mm STRAIGHT ROD, THEN REMOVE COLLAR (006) AND SPRING (005) .

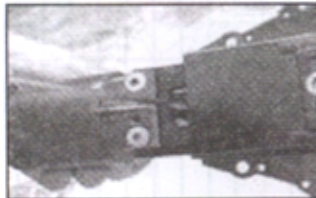

LOOSEN SCREW (510) WITH 3 mm HEXAGON WRENCH KEY TO REMOVE BLOCK (004) THROUGH WINDOW .



LOOSEN SCREWS (501) WITH 3 mm HEXAGON WRENCH KEY . REMOVE CAP (001) .



REMOVE PISTON ASSEMBLY . LOOSEN NUT (504) WITH 10 mm SPANNER . REMOVE PISTON (002) AND EXCHANGE A NEW ONE

PNEUMATIC CARTON STAPLER

<u>ITEM NO.</u>	<u>PARTS NO.</u>	<u>DESCRIPTION</u>	<u>SPECIFICATION</u>
001	A01200110	CAP	NO MARK
001	A01200111	CAP	SACA
002	A02800201	PISTON	
003	A02800301	PISTON ROD	
004	A00100401	BLOCK	
005	A00100501	SPRING	
006	A00100601	COLLAR	
007	A01200403	BODY	
008	A00100802	AIR PLUG	U.S.A TYPE
009	A00100902	BLOCK	
010	A00101001	SPRING	
011	A00101101	TRIGGER	
012	A00101201	SPRING	
013	A00101301	ROD	
014	A00101402	TRIGGER'S CONTROL	
015	A00101501	SPRING	
016	A00101601	VALVE	
017	A00101702	TUBE	
018	A00101801	ADJUSTING ROD	
019	A00101901	ADJUSTING PLATE	
020	A01102501	FRONT PLATE	
021	A00102102	RIGHT TEETH	19mm
022	A00102202	LEFT TEETH	19mm
023	A00102301	TEETH SEAT	
024	A00102401	PLATE	
025	A00102502	BLOCK	
026	A00102605	DRIVER	MGA-13858-A
026	A01201706	DRIVER	MGA-11458-A
027	A00102703@	COVER UNIT	
028	A01101402	MAGAZINE SEAT	
029	HA-19-35-P2	MAGAZINE	MGA-13858-A
029	HA-19-32-P2	MAGAZINE	MGA-11458-A
030	A01102403	SPRING	
031	A01102201	BRACKET	
032	A01101801	PUSHER	MGA-13858-A
032	A01101803	PUSHER	MGA-11458-A
033	A01102001	ROD	
034	A01102101	SPRING	
035	A01101901	STOPPER	
036	A00105001	WASHER	
051	BAI1404	SILENCER	
501	BAC0604142	HEX.SOC.HD.BOLT	M4 x 0.7-14

503	BAB017537	O-RING	w1.78 x w53.7
504	BAD02061	HEX.NUT	M6 x 1
505	BAT03061	WASHER	1/4" x 5/8" x 1T
506	BAB017076	O-RING	w1.78 x w7.65
507	BAB057476	O-RING	w5.7 x w47.6
508	A00104101	WASHER	w8 x w23 x 1.6T
509	BAE01042	SPRING WASHER	M4
510	BAC0404062	HEX.SOC.HD.BOLT	M4 x 0.7-6
511	BAA025014	SPRING PIN	w2.5-14
512	BAC0312122	HEX.SOC.HD.BOLT	M12 X 1.75-12
513	A00104401	TRIGGER SCREW	M4 x 0.7-7
514	BAE01042	SPRING WASHER	M4
515	BAA030020	SPRING PIN	w3-20
516	BAE02042	OUTSIDE TEETH WASHER	M4
517	BAC0404102	HEX.SOC.HD.BOLT	M4 X 0.7-10
518	BAA030010	SPRING PIN	w3-10
519	BAB017124	O-RING	w1.78 x w12.42
520	BAB017076	O-RING	w1.78 x w7.65
521	BAB016145	O-RING	w1.6 x w14.5
522	BAB016150	O-RING	w1.6 x w15
523	BAB016155	O-RING	w1.6 x w15.5
524	BAB016160	O-RING	w1.6 x w16
525	A00104701	ROD	w4.9-17.5
526	BAC0306142	HEX.SOC.HDLESS.BOLT	M6 x 1-14
527	BAC0408162	HEX.SOC.HD.BOLT	M8 x 1.25-16
528	BAE01082	SPRING WASHER	M8
529	BAA030010	SPRING PIN	w3-10
530	BAC0605142	HEX.SOC.HD.BOLT	M5 X 0.8-14
532	BAC0205122	HEX.SOC.FLAT COUNTERSUNK HD.SCREW	M5 X 0.8-12
533	A00104501	PIN	w3.97-13
534	A00104602	PIN	w6.05-8
535	BAC0604102	HEX.SOC.HD.BOLT	M4 X 0.7-10
537	BAA060016	SPRING PIN	w6-16
538	BAD01051	LOCK NUT	M5 X 0.8
539	BAD01051	LOCK NUT	M5 X 0.8
540	BAF22002	C-RING	w20
541	BAF10252	E-RING	w2.5
542	BAG010602	HELI-COIL	M6 X 1.0-2D
543	A00104901	PLASTIC PIN	
544	C0011201	COUNTER BALANCE HANGER	
545	BAF22002	C-RING	w20
546	BAC0204062	HEX.SOC.FLAT COUNTERSUNK HD.SCREW	M4 X 0.7-6

